

ACRO BASE SYSTEM

User's manual

SUPAIR-VLD
PARC ALTAÏS
34 RUE ADRASTÉE
74650 ANNECY CHAVANOD
FRANCE

45°54.024'N / 06°04.725' E



SUPAIR manufactures its products in Europe.
The majority of the components used come from Europe.

Indice de révision: A1



Thank you for your choice of an ACRO BASE System. We are proud to join you on your journey in our common passion : paragliding.

SUPAIR has been designing, producing and selling accessories for free flying activities since 1984. By choosing a SUPAIR product you benefit from almost thirty years of expertise, innovation and listening. This is also our philosophy : working endlessly to develop better products and to maintain a high quality production in Europe.

We trust that you will find this user's manual comprehensive, explicit and hopefully pleasant to read. We advise you to read it carefully !

On our website www.supair.com, you will find the last up to date information about this product. If you have any further questions, feel free to ask one of our retailers. And of course, the entire SUPAIR team are at your disposal through info@supair.com

We wish you many safe flying and enjoyable hours, and happy landings

The SUPAIR team

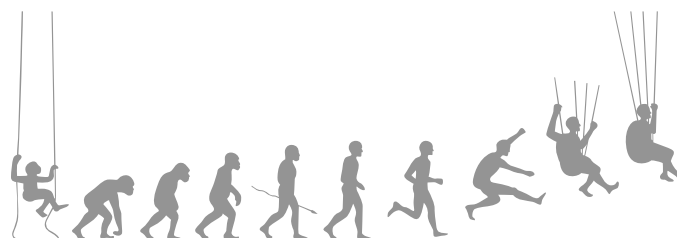



- You must have read, understood and accepted upon the purchase of your harness to FOREVER RELEASE, WAIVE AND DISCHARGE the RELEASED PARTIES from and against any and all claims asserted, liability established, demands, or causes of action that I and/or a third party may hereafter have for SPORTS INJURIES, however caused, even if caused in whole or in part by the action, inaction and/or negligence (whether active or passive) of any of the RELEASED PARTIES, to the fullest extent of the law.
- The BASE System is a device aimed at increasing pilot safety in case of an unintentional and unexpected total paraglider control loss.
- The ACRO BASE System is a complex product : you must imperatively proceed in reading the entire content of this brochure while fully understanding its content pertaining to the product's proper use (specifically page 5, page 12, page 13, page 14 and page 29 of this manual).
- The ACRO BASE System was designed for the paragliding activity only. It is NOT to be used for the Base-Jumping or Free Falling activities.
- This BASE wing is not equipped with a slider and therefore no intentional free-fall (in other words, no opening delay to the BASE wing) can be done without consequently bringing an onset of physically dangerous and potentially deadly results to yourself. It imperative to double check the proper connexion between the pod bridle and the right carabiner.
- 3 types of control procedures and maintenance (every 1, 6 and 12 months) must be performed. Non compliance to their scheduled dates; total, partial or full omission will have serious consequences to your safety. Refer to page 29.
- In case of an accidental fall into the wing, the BASE System would not work. The only recourse of action would be to deploy the classic reserve parachute located beneath the seat which could save your life – refer to page 19 -
- Be aware of the codes, laws and regulations in place in the country where you will intend to be using the ACRO BASE System.
- Any voluntary intent to use the BASE System without having an emergency situation at hand, is prohibited.
- Any use of the BASE System outside its recommended guide lines is extremely dangerous and could result in serious injuries and possible death.

Warning	3
List of contents	4
BASE System technical information	5
Introduction	6
Technical specifications	7
Size choice	8
Nomenclature	9
Harness overview	10
BUMPAIR assembly	11
Setting up the release system.	12
Pod BASE System installation.	13
BASE pocket fastening.	14
Installation of the reserve parachute located beneath the seat.	15
Proper parachute riser layout.	17
Very important remark on underseat rescue bridles gearing	18
Installing the speed-bar system.	21
Position setting.	23
Flight behavior.	24
Flight phases	26
Packing the BASE wing.	28
Mandatory controls	30
Maintenance	31
Complements/Accessories	34
Service Book	35

Pictures credits
SUPAIR,
Raul RODRIGUEZ,
Roland WACOGNE



The Patent Pending BASE System is composed of 4 distinct functioning elements :

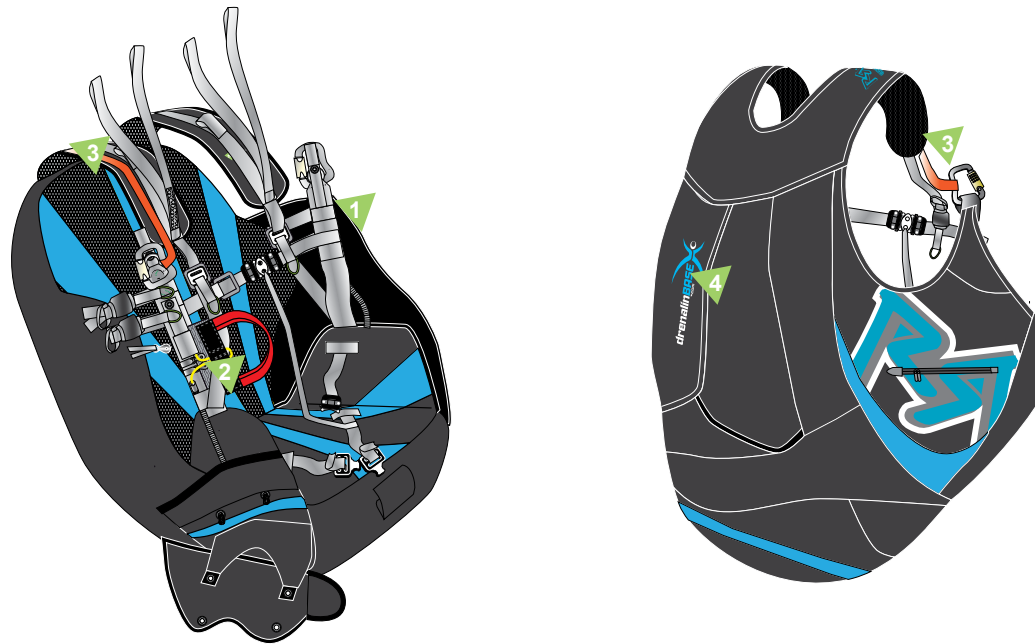

1. A 3-Ring system as used in SkyDiving; offering a strong resistance factor with an easy unlatching sequence under load. The harness conforms to the EN651 norm (paragliding harness) : each and every connection point was tested at 1500 daN (or a 1500 kg equivalency), while able to be unlatched under 20 daN and 5 G acceleration. Refer to page 12.

2. A handle to extract and jettison the BASE System. By pulling on the handle, the 3-Ring cable locking system, releases the rings and jettisons the paragliding wing which turn, acts as an extractor to the BASE wing.

3. The connecting bridle between the BASE wing pod and your harness's right carabiner, ensures the BASE wing extraction upon freeing the 3-Ring System. Refer to page 13.

4. The BASE wing is contained in a pod located inside a specially designed dorsal pocket. The wing is packed following the straight forward folding technique of a BASE-Jump canopy. Refer to page 27.

The photos below, illustrate a BASE System opening sequence.



The ACRO BASE System is the latest creation borne out of the new cooperation between SUPAIR and Raul Rodriguez/ACROWINGS. The entire system integration was put together by Jean-Noel Itzstein from ADRENALIN BASE.

The ACRO BASE System is a significant added new safety feature enabling you to maximize your aerobatic routine with better peace of mind.

However, the ACRO BASE SYSTEM is a complex product demanding from its user a full manual understanding : any setup mistake

Therefore, we stress that a thorough comprehensive reading of the owner's manual must be done. If in doubt about any part of its content, please contact a SUPAIR retailer or SUPAIR itself for answers at info@supair.com

After reading this manual, we suggest you check your harness by hanging in it before flying.

N.B : Three important icons will help you when reading this manual



Advice



Caution !



Danger !!

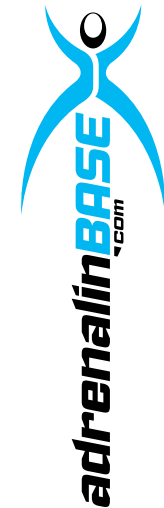

Technical sheet

- A** Back height (cm)
- B** Leaning setting height (cm)
- C** Seat length (cm)
- D** Seat width (cm)
- E** Carabiners height (cm)
- F** Carabiners distance (cm)

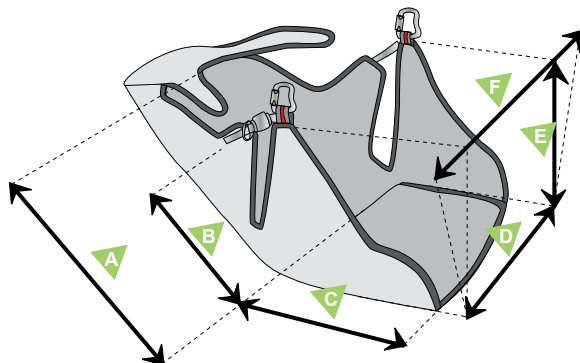



Model	ACRO Base System M
Pilot size	bla
Pilot's weight	bla
Harness weight (+ carabiners+speedbar)	10.8 kg
Designed for	Paragliding only
Back height (cm)	67
Leaning setting height (cm)	34
Seat length (cm)	42
Seat width (cm)	37
Carabiners height (cm)	39
Carabiners distance (cm)	37 - 60
Impact damping system : Airbag (Volume)	No
Impact damping system : Bumpair (Thickness)	Yes- 17 cm
Homologation	EN 1651 - LTF
Flight : tandem (Pilot- Passenger)	No-No
Flight : acrobatic flying	Yes
Take-off : Winching	No
Quick-out carabiners compatibility	No

Choosing your harness' size is important. You will find here below a height/weight table that will help you in your size choice. Nonetheless we advise you to try out the harness under a hanging device and in different sizes at one of our retailers in order to choose the correct size.

For a complete list of our retailers, please click here : www.supair.com

Size Weight	1m45	1m50	1m55	1m60	1m65	1m70	1m75	1m80	1m85	1m90	1m95	2m	2m05
50													
55													
60													
65													
70													
75													
80													
85													
90													
95													
100													
105													
110													

-  Preliminary test under hanging device
-  M
-  Preliminary test under hanging device

- 1 Fiberglass reinforced wooden seat plate.
- 2 ACRO BASE System reserve parachute handle (ref : BS-M) (x2).
- 3 Reserve parachute handle for pod located beneath the seat (ref : A3).
- 4 Stainless steel (Inox) 45 mm (x2) carabiners.
- 5 Slim double-stage speed-bar.
- 6 Speed-bar connection hooks (x2).
- 7 BASE System wing (folded).
- 8 BASE System pod.
- 9 Split risers (for reserve parachute located beneath the seat).
- 10 Maillon Rapide® Inox 7 mm
- 11 O rings (x2)
- 12 BUMPAIR 17 cm

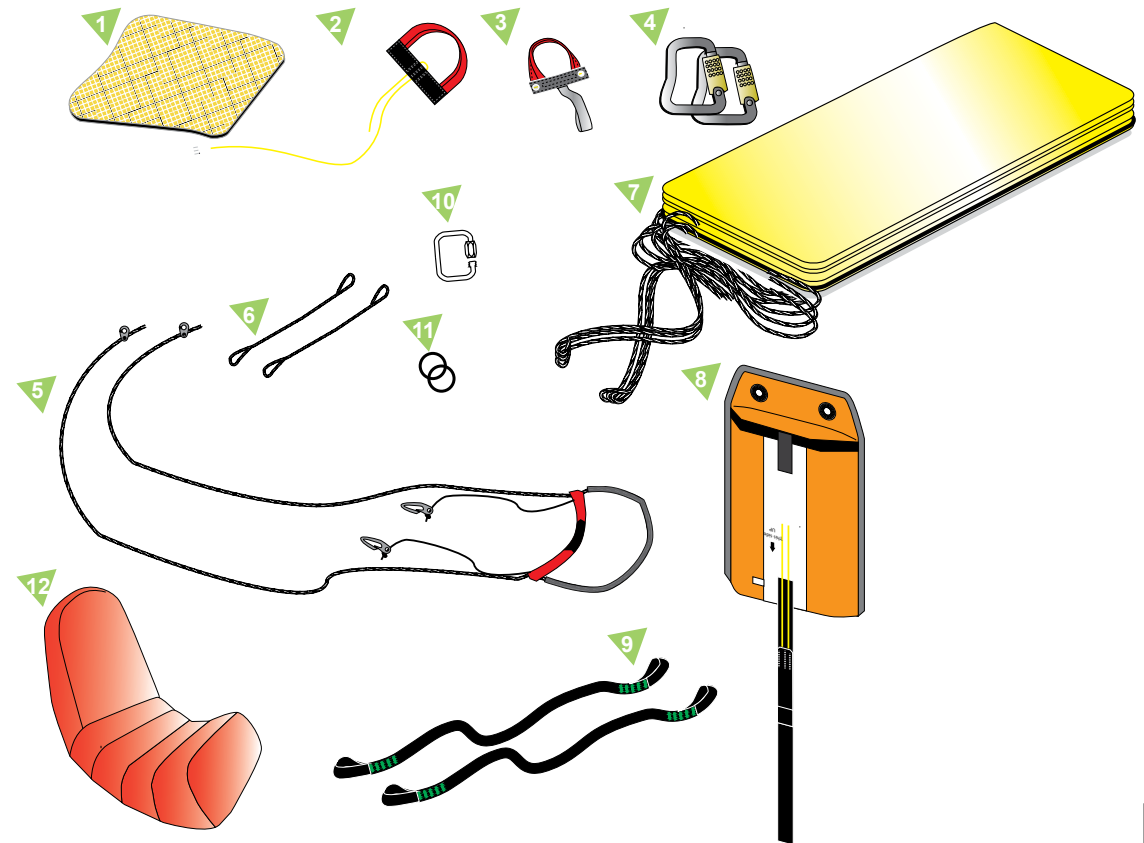

This illustration will help you during your reading.

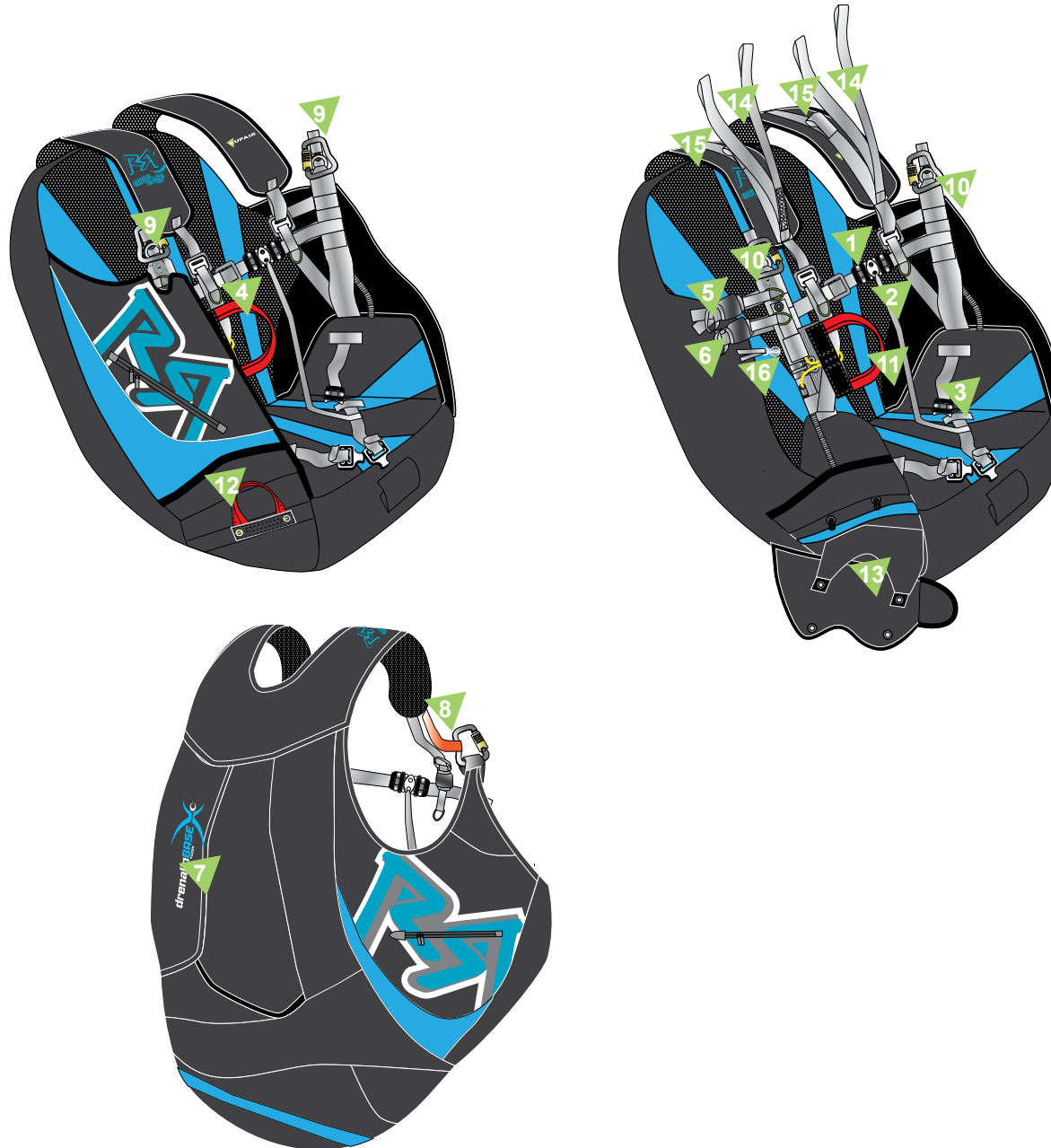

- 1 Chest strap quick release buckle.
- 2 Safe-T-strap (SUP'AIR Patent A1-1832/981).
- 3 Leg strap quick release buckle.
- 4 Chest strap adjustment.
- 5 Backrest tilt adjustment.
- 6 Lumbar support.
- 7 BASE System dorsal reserve parachute pocket.
- 8 BASE System pod connection strap – Carabiner.
- 9 45 mm self-locking carabiners.
- 10 Main wing 3-ring jettisoning system.
- 11 Acro BASE System handle.
- 12 Reserve parachute handle for a pod located beneath the seat.
- 13 Reserve parachute container located beneath the seat.
- 14 BASE System risers/harness connection.
- 15 Reserve parachute risers connection beneath the seat.
- 16 Speed system pulleys.

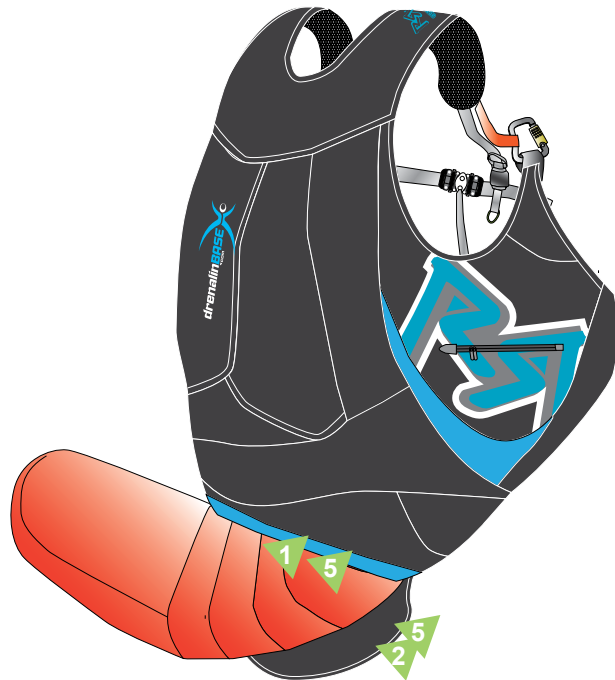

The BUMPAIR is only installed once. There is no need to take it out of its container afterward unless in case of a severe impact or water landing : it would then be necessary to inspect it for possible damage (tear, ripped fabric or stitching, etc.).

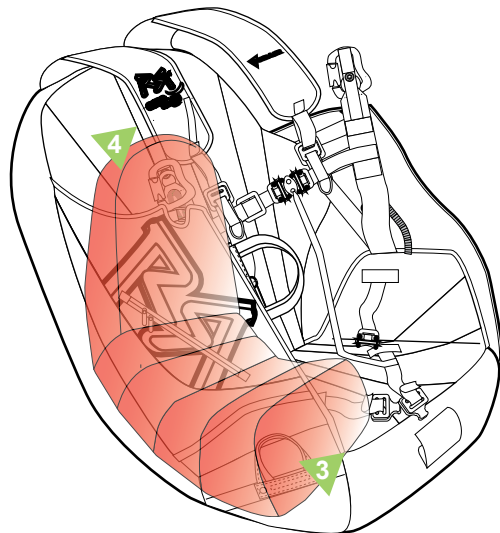

- 1 Open the lower zipping pocket.
- 2 Open the internal pocket zipper.
- 3 Push the forth BUMPAIR section forward. Be certain of its correct positioning after insertion by sliding your hand between the wall and the BUMPAIR.
- 4 Push the upper section of the BUMPAIR. Be certain of its correct positioning by sliding your hand between the wall and the BUMPAIR.
- 5 Neatly close the two zips.

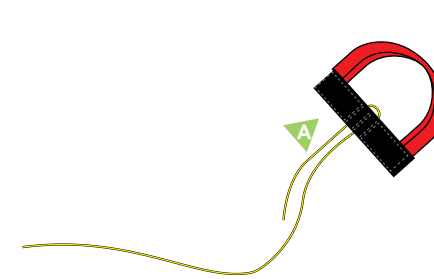
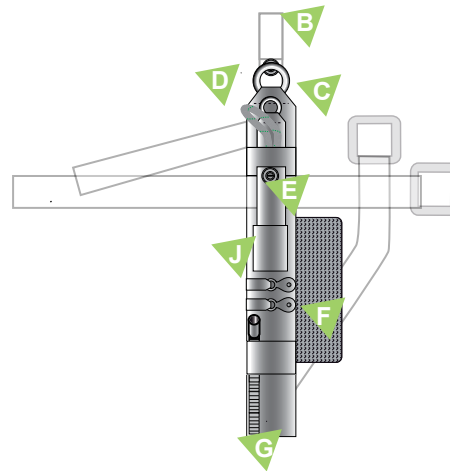
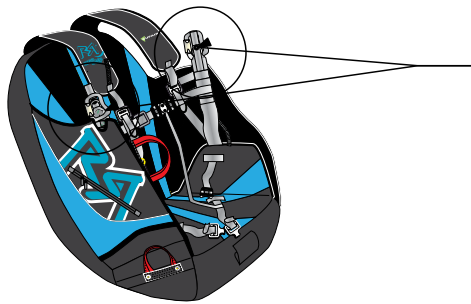

You CAN NOT have any doubt about the installation procedure! If the case, start it all over again.
Check the release system prior each takeoff !
DO NOT use any carabiners other than those provided by the manufacturer.

4 Step :
 Check thoroughly that all is properly installed during a test on the ground.

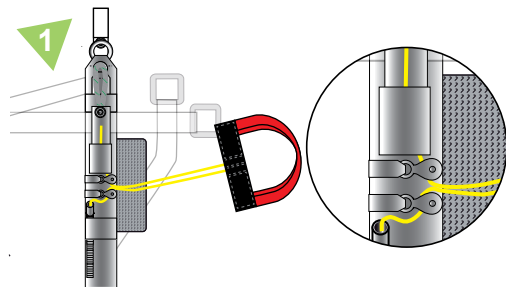

Step 1 :
 Push the cables through the pulleys, then slide them into the sleeve. Finally, insert the cables in the elastic guide (right side).

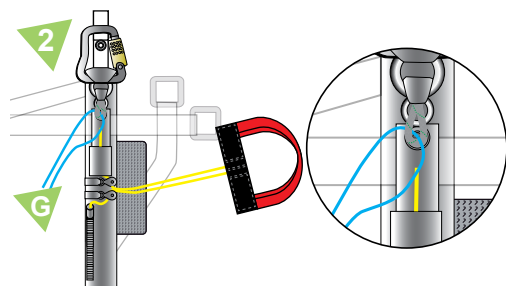

Step 2:
 Push the first ring in the carabiner. Then push the second ring inside the first ring and place the white flat loop in the second ring using the packing line (8, in blue).

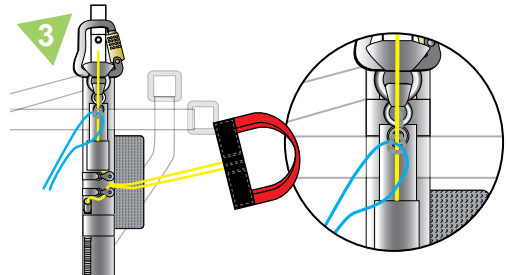

Step 3:
 Using the packing line, push the white flat loop through the grommet on the bridle, then insert the cables through that loop coming out on the other side of the grommet.

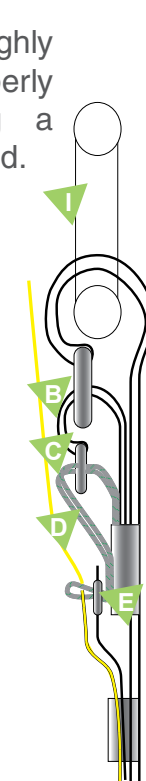

- A** BS Handle
- B** First ring.
- C** Second ring.
- D** White flat loop.
- E** Grommet.
- F** Pulleys.
- G** Cable handle sleeve.
- H** Line
- I** Carabiner.
- J** Elastic guide.

Installing the bridle connecting the pod to the carabiner.



Caution !

When connecting the BASE wing to the right Carabiner, be certain for the bridle not to be twisted.

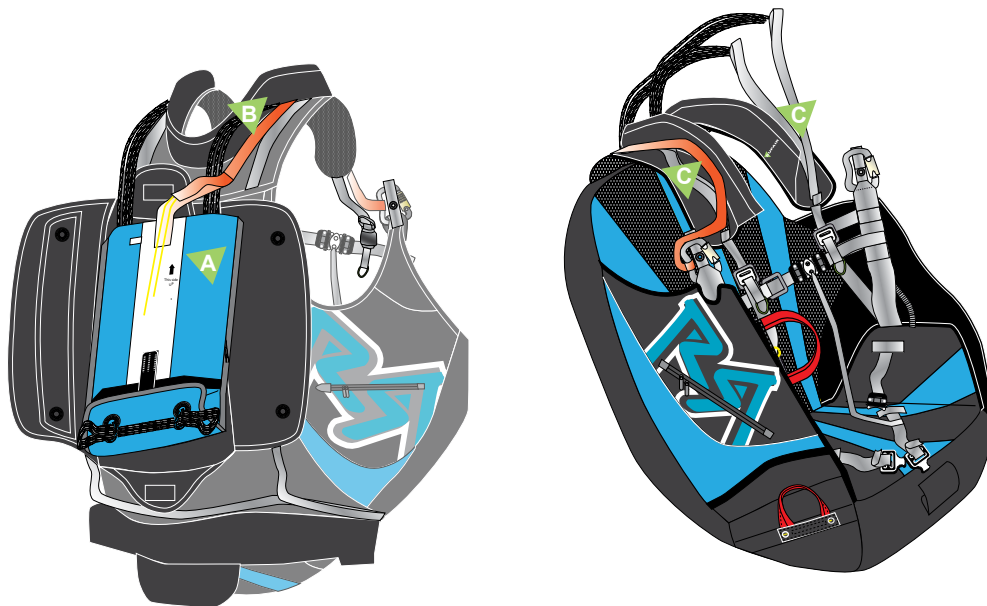

- A** Folded BASE wing pod connected to the BASE wing bridles.
- B** Connection bridle to the carabiners (pre-installed at the factory : do not take apart).
- C** Parachute BASE System to harness connection bridles.
- D** Fastening Velcro for the Parachute BASE System to harness connection bridles.
- E** Self-locking stainless steel (Inox) carabiner for the connection paraglider-harness.

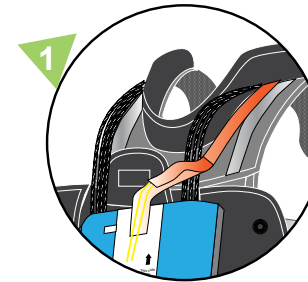

1. Position the pod correctly (logo “ This side up ” with the arrow pointing upward). Pull the the connection bridle out of the pod and place it over the BASE wing connection risers. Be certain not to have any twist and for the bridle not to be wrapped around the risers.

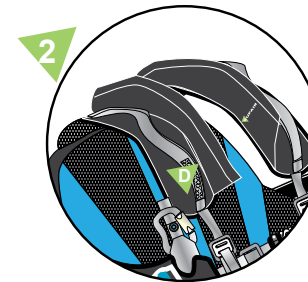

2. Position the connecting bridle 's Velcro side (B) onto the receiving and corresponding Velcro side (D).

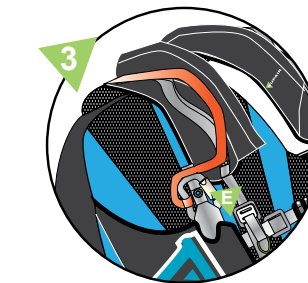

3. Be certain not to have the connecting (B) bridle positioned with any twist and not wrapped around the wing to harness connecting risers (C). Connect the bridle to the right carabiner (E).



Caution !

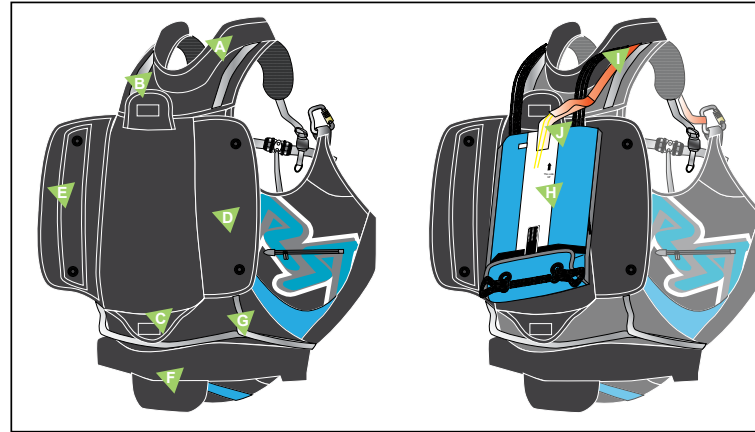

- ▲ A Shoulder flap.
- ▲ B Upper flap.
- ▲ C Lower flap.
- ▲ D Right flap.
- ▲ E Left flap.
- ▲ F Under the seat parachute flap.
- ▲ G Under the seat parachute risers.
- ▲ H BASE wing folded pod.
- ▲ I Carabiner connection bridle.
- ▲ J Pocket supporting/closing cables.

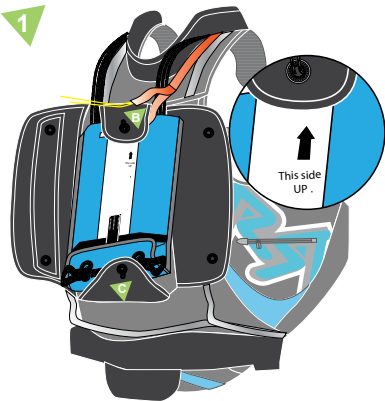

1. Position the pod while respecting the correct direction («this side up») as well as avoiding any connection bridle twist. Fold the upper and lower flaps.

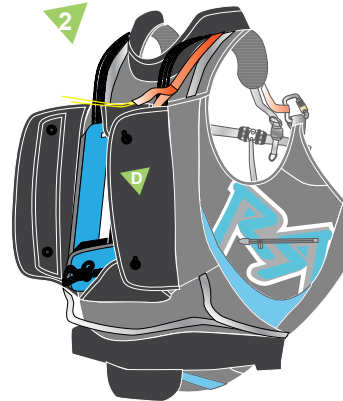

2. Fold the right flap, then, using a packing string, pull the small lines following the number sequence.

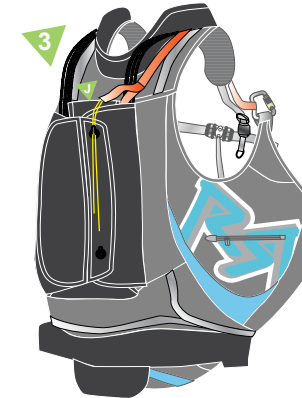

3. Push the two cables through the upper flap loop. Gently pull the string out.

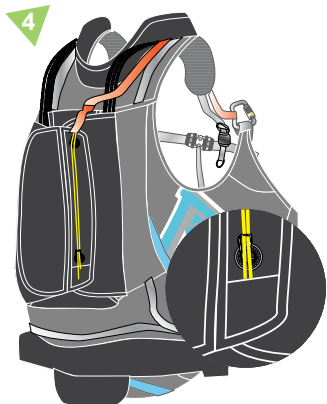

4. Repeat procedure 3 for the lower flap. Place the cables ends in the protective sleeve.

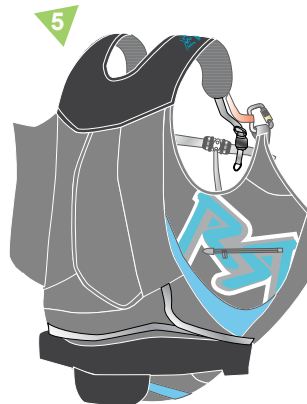

5. Fold over the shoulder flap then the riser cover flap for the under-seat parachute location.

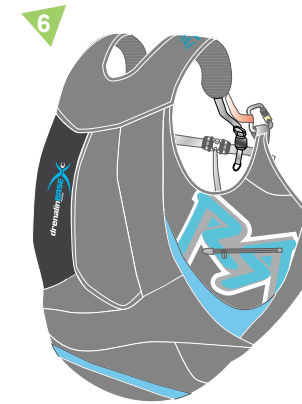

6. Fold the "Adrenalin BASE" embroidered flap into the cover made for it.



Installation of the reserve parachute located beneath the seat.

Installation of the parachute located beneath the seat : characteristics.

- Lateral pocket with 1 flap (+ 1 supporting internal flap).
- Locking sequence via cables.
- Handle right side.
- Volume : 3 to 6,5 liters.
- Adapted to receive the rescue parachutes SUPAIR Light or X-tralite, as well as other SUPAIR solo parachutes or from other brands (check for compatibility).



Thank you for carefully reading the followings! We advise you to have the initial rescue parachute installation done by someone knowledgeable with the process.



We strongly advise you against using a Rogallo (or any steerable) Rescue parachute for the underseat Rescue. There is a risk of mirro effect.



The rescue located beneath the seat is vital for the following reasons :

- None or poor opening of the BASE wing (line-over).
- Pilot falling into the wing.
- Elevation over the ground inferior to 100m.

- A** Handle for rescue parachute located beneath the seat (ref : A3).
- B** Parachute properly pact in its pod.
- C** Parachute lines.
- D** Parachute risers (standard or "Y").

Pod handle connection.

1. "Y" risers : Make a "loop to loop" connection to attach the risers to the harness using the 6 or 7 mm (x 2) stainless steel (Inox) Maillons Rapides®. Refer to page 13.

2. Standard risers : use the 7 mm stainless steel (Inox) Maillon Rapide®. Refer to page 14.

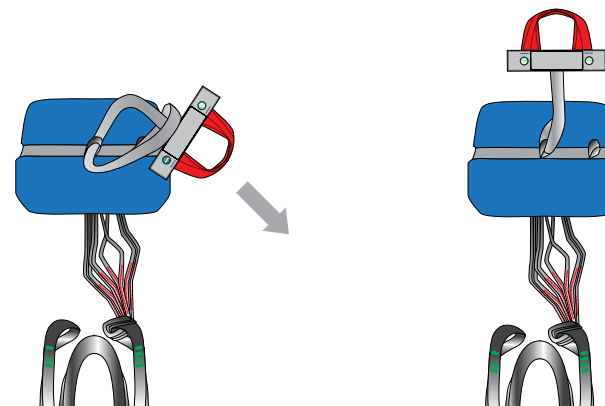
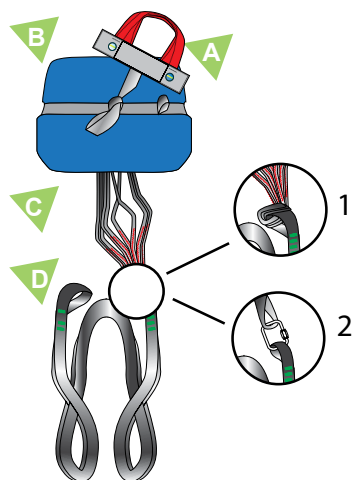

1. Attach the handle to the center connection point using a "loop to loop" configuration.

2. Tighten securely the "loop to loop" connection.

Parachute installation inside the under-seat pocket.

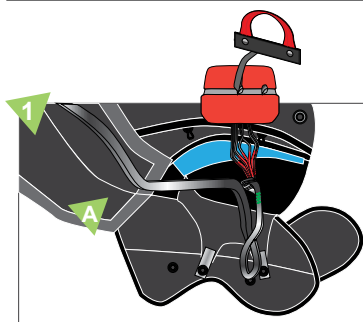
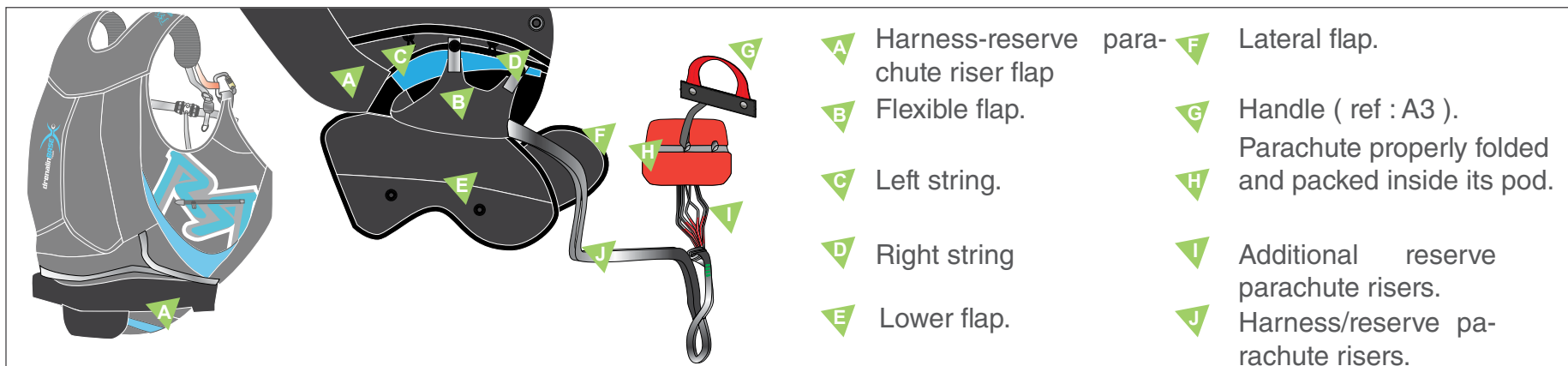

1. Place the risers harness/reserve (J) underneath the flap (A).

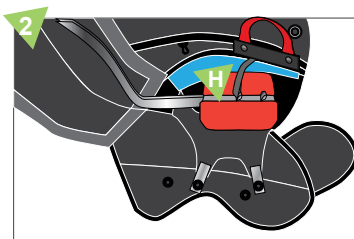

2. Neatly tuck away the parachute risers (I) left out of the pod (H) inside the reserve parachute pocket.

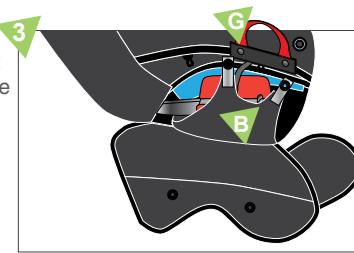

3. Close the flap (A) and correctly position the handle (G) then, fold the flexible flap (B).

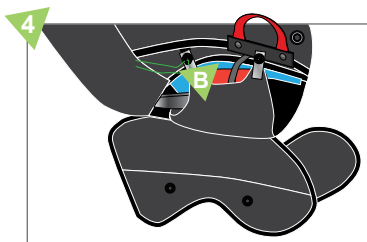

4. Using a packing string, push the line (C) through the flexible flap left grommet (B).

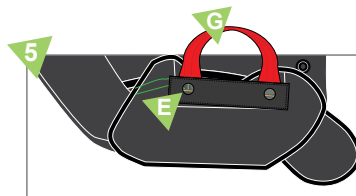

5. Using the packing string, pull the line through the lower flap left grommet (E) then inside the handle cable (G). Gently pull the packing string out.

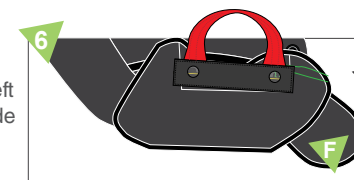

6. Repeat the procedures 4 and 5 with the right grommets found on flaps B and E.

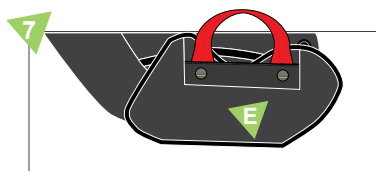

7. Connect the handle (G) Velcro strip, to the flap (E) receiving Velcro strip (male to female).Tuck away the handle extremities (G) in their respective housing on flap (E).

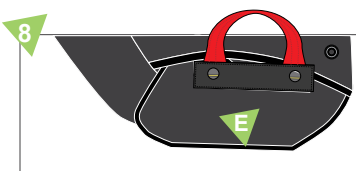

8. Tuck away the flap (E) "bumps" in their respective housing.



Check the completed installation during a hang-test.



It is extremely important to properly layout the parachute risers as depicted in the graphics below.

A poor riser arrangement could prevent a successful activation of the BASE System and consequently endanger your life.

- A** Bridle connection to the carabiners.
- B** BASE System/harness parachute risers connection (2 on each side)
- C** BASE wing lines.
- D** Maillon Rapide connection system (see page 17) or "loop to loop" (see page 18).
- E** Riser connections harness to rescue parachute located under the seat.
- F** Shoulder bridle connection for parachute under the seat.
- G** Shoulders

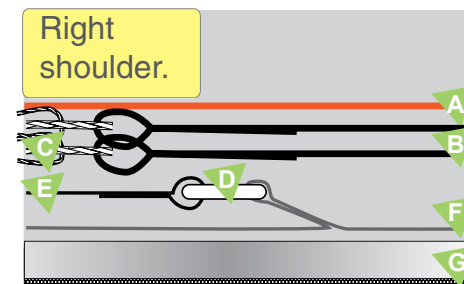
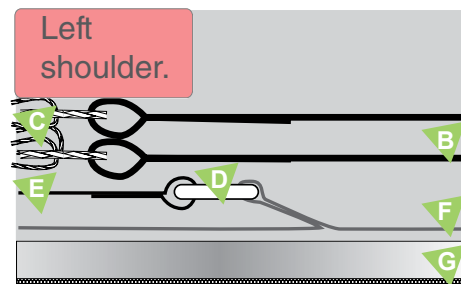
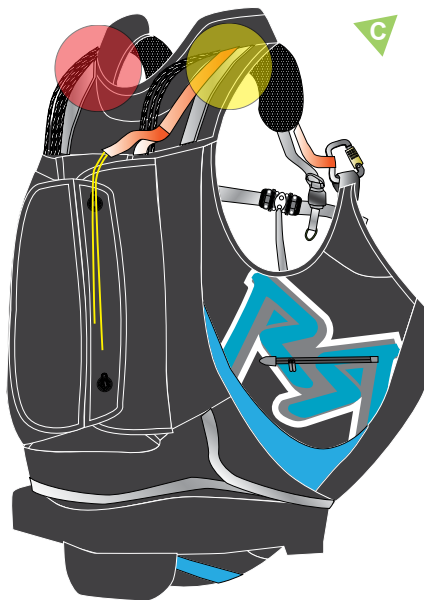

Toward the shoulder front. ➡

Toward the shoulder front. ➡



Very important remark on underseat rescue bridles gearing



It is very important that you check the correct passing of the rescue bridles.

An error in this passing could lead to a very delayed opening and consequently have dangerous consequences.

A

Please check that the underseat rescue bridles are correctly placed under the BASE rescue bridles (as described in the previous page).

B

Please check that the bridles are correctly passing behind the lateral flaps.

C

Please check that the bridles are correctly passing behind the lower flap.



1. Place the Maillon Rapide® (locking gate toward the top, facing outward) and push it through the bridle loop under the flap. Place the O ring in the Maillon and twist it in a figure 8 configuration.

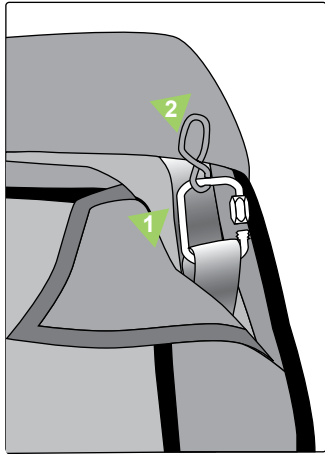

2. Push the riser through the upper free "8" shape section and in the Maillon Rapide®.

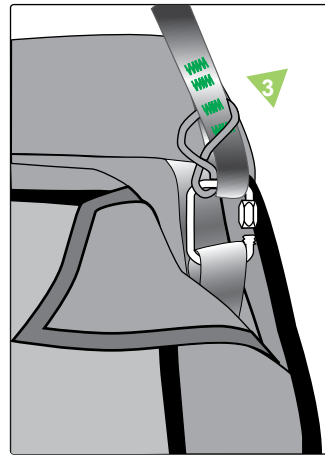

3. Create a new twisted loop with the O ring before inserting it into the Maillon Rapide®.

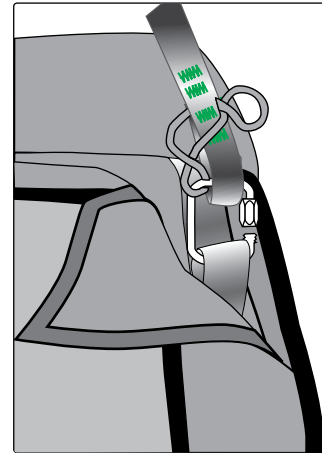

4. Repeat procedures 1,2,3 with an additional O ring for the connection to the harness. Tighten the Maillon Rapide® locking gate securely, if necessarily with pliers.

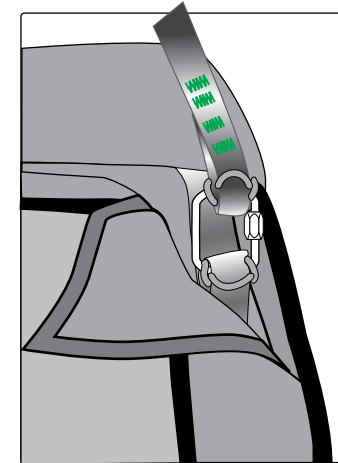

5. Tuck away the risers excess under the flaps.

1 Maillon Rapide® Inox 6 mm

2 O rings

3 Risers for reserve parachute located beneath the seat.

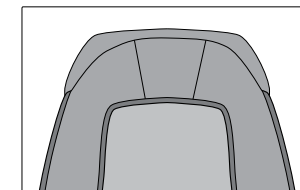
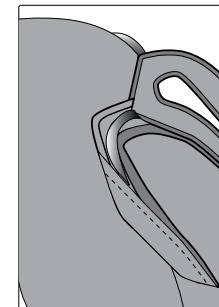
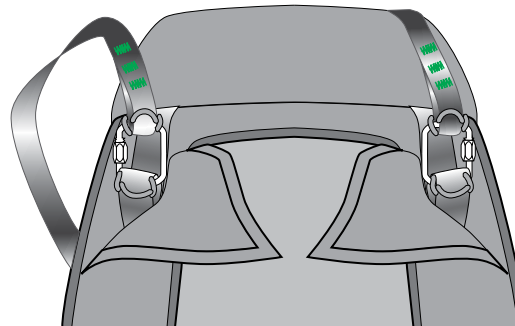

Your ACRO BASE SYSTEM is pre-equipped with light standard split risers.

1. Make a “loop to loop” connection between the risers and the bridles hooking points to the rescue parachute.

2. Tighten securely the “loop to loop” connection.

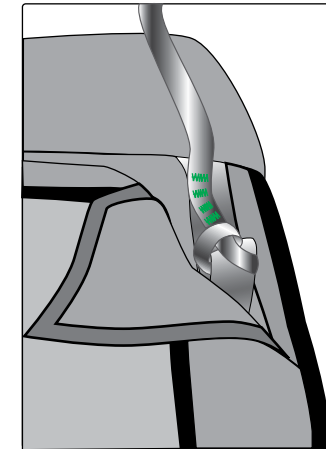
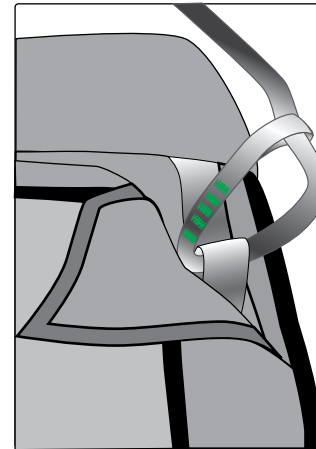
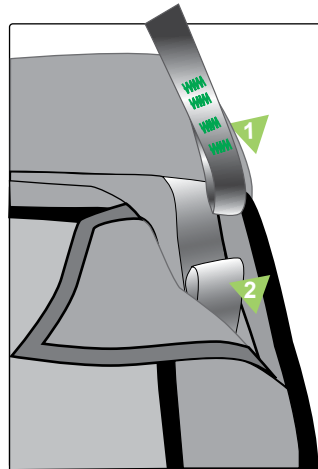

3. Tidy-up and tuck away the excess risers under the flaps.

1 Risers for the reserve parachute located beneath the seat.

2 Connection points for the reserve parachute located beneath the seat.

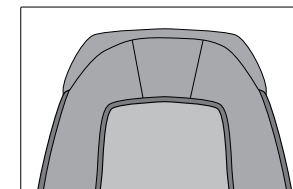
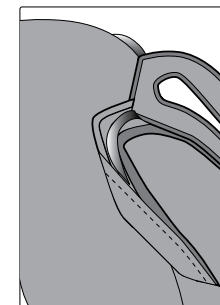
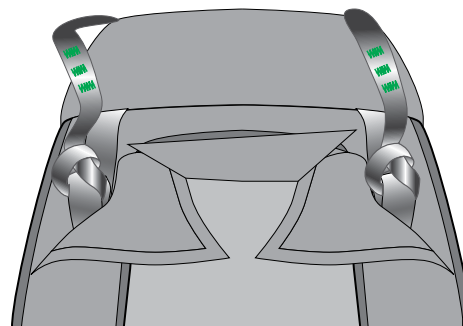

Setting-up the jettisoning speed-bar system.



For the BASE to work efficiently, it is imperative for the speed-bar to separate itself from the wing at the exact moment the main wing is jettisoned. Hence, it needs a modification on the paragliding risers.

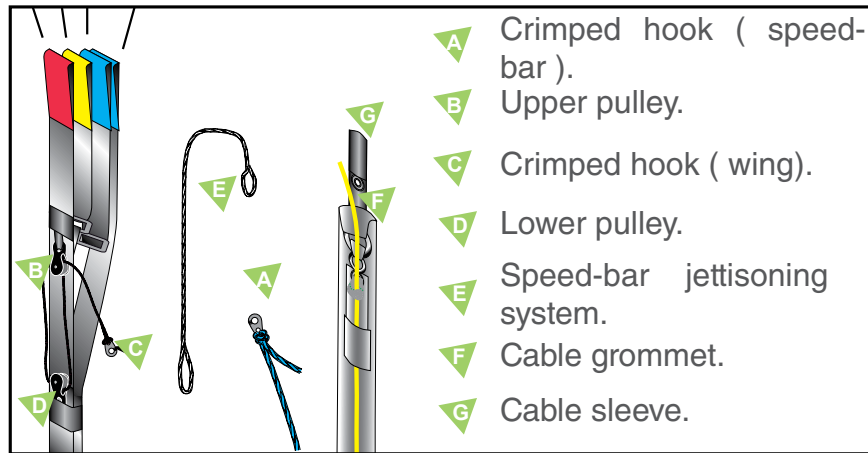



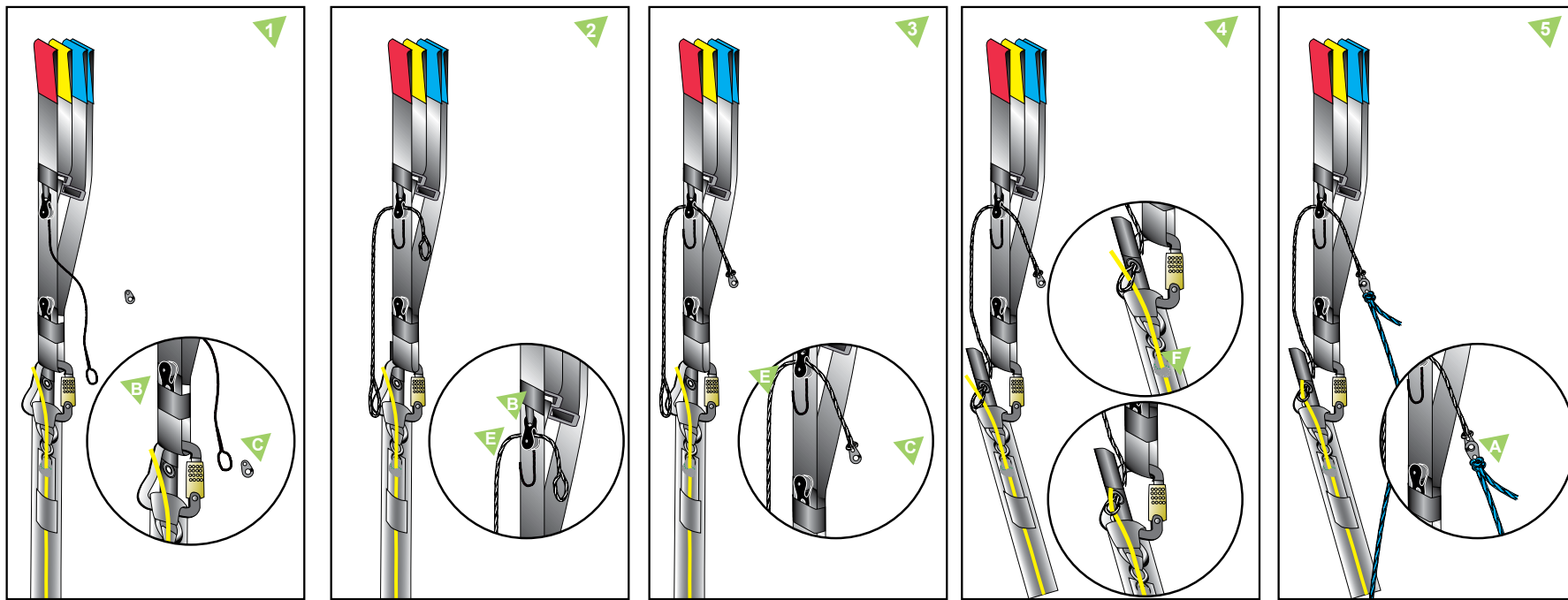







1. Remove the crimped hook and pull out the speed-bar line from the pulleys. Tuck away this line with a piece of Velcro or tape to prevent any interference with the system.
2. Push the speed-bar jettisoning device through the upper pulley.
3. Connect the crimped hook (wing) in a "loop to loop " configuration.
4. Push the jettisoning device's lower section through the grommet and guide the yellow cable through the jettisoning device. Tuck away the cable's extremities into the sleeve designed for it.
5. Fasten the speed-bar crimped hook to the wing's riser crimped hook. Then, adjust the line accordingly.





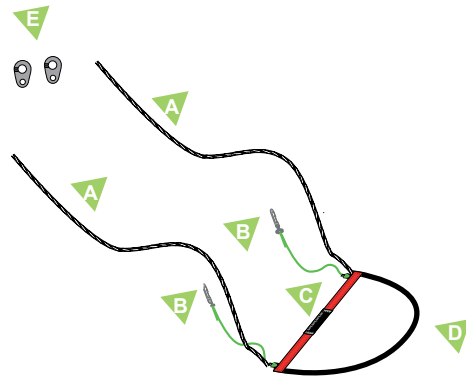
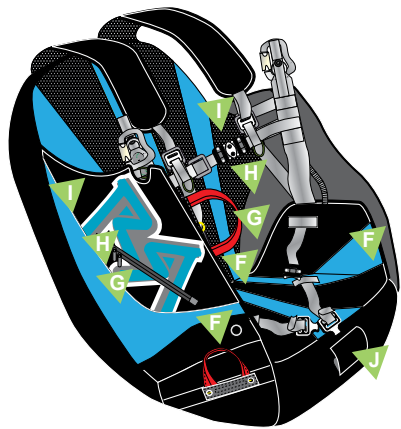

Speed-bar connection to the harness.

A light weight speed-bar system is delivered with the harness. The illustration below shows how to instal it.

- | | | |
|---|--|---|
|  Lines. |  Crimped hooks. |  Exit guide. |
|  Elastic recoil cords. |  Grommet. |  Speed-bar travel. |
|  Second stage. |  Bridle with grommet. | |
|  First stage. |  Pulley. | |



-  Push cord (A) through speed-bar grommet (F).
-  Push the cord through pulley (H).
-  Pull the cord out of the side panel through the exit guide (I).
-  Connect the recoil elastic cord loops (B) to the bridle with grommet (G). Repeat procedures 1 and 4 for the other side.

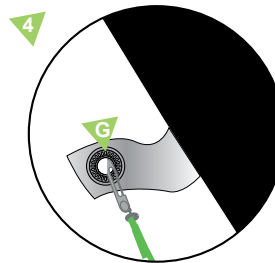
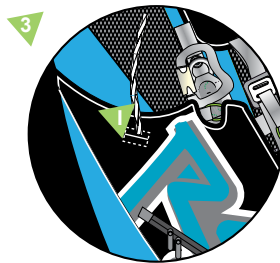
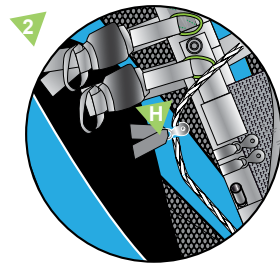
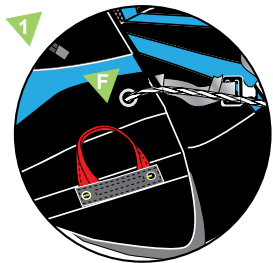



Adjusting the harness before taking-off is extremely important.

- 1 Dorsal adjustment.
- 2 Lumbar support.
- 3 Shoulder straps adjustments.

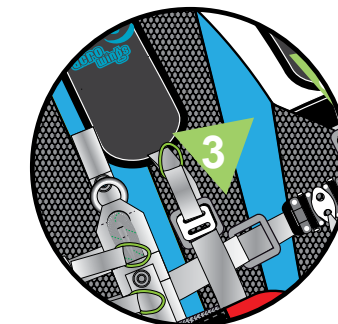
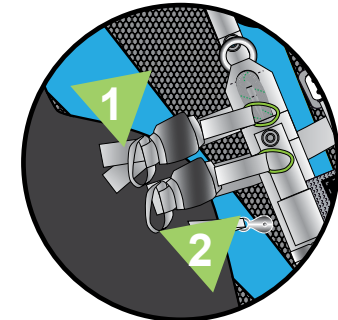
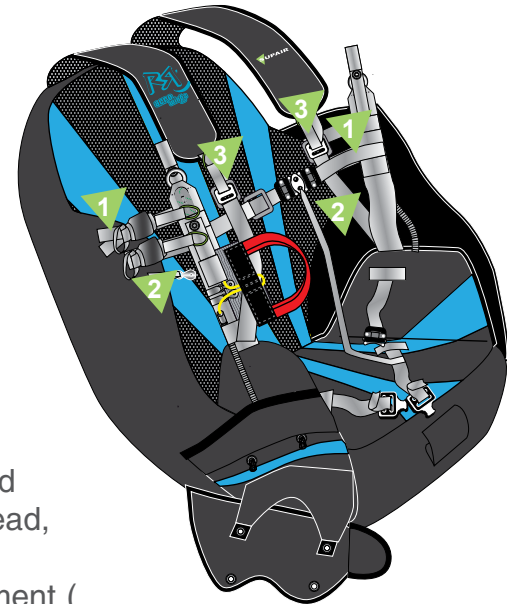

A Backrest tilt adjustment.

Adjust the backrest angle (1) by pulling the trim cord/loop and adopt a more vertical posture, or pull the black webbing instead, to release the tension and adopt a more reclined posture. You can increase or decrease lumbar support using adjustment (2).



B Shoulder straps adjustments.

Tighten the shoulder straps by pulling the loop forward. Loosen by pulling the tubular webbing rearward. Resting on the shoulder straps contributes to the overall comfort level and must be precisely adjusted (not too tight or too loose).

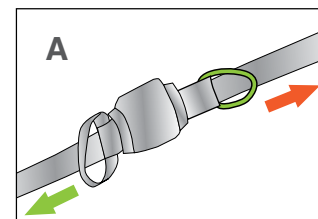

Loosen

Tighten

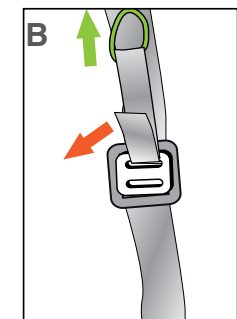

serrer

The ACRO BASE SYSTEM is a harness specially made for paragliding acrobatics. It is a precise, stiff and reactive, giving you maximum control during aerobatic figures.

Keep in mind that we want to see you practice this specialty with peace of mind and for as long as possible. The best gear will not protect you against over confidence or a cascade of mishaps.

Be prudent ! Happy flights !



Pre-Flight check.



- Check that the harness and the carabiners did are not damaged.
- Check thoroughly that the rescue handle's cable end has not got outside the snappers' flaps
- Check that your personal settings have not been modified.
- Check that all zippers and buckles are properly closed.
- Check that the speed-bar is properly adjusted and connected to the wing (refer to page 20).
- Check that no rigging line or other object comes in contact with the rescue parachute handle.



A thorough visual check of the release mechanism prior each flight is mandatory and must be viewed as an absolute necessity when keeping in mind that an accidental unfastening of the system could have dangerous consequences.

After a thorough weather conditions analysis, when the decision to fly has been taken, put your harness on :



- Securely fasten the buckles (thigh straps, safe-T-bar and chest strap buckles).
- Check for the carabiners to be securely locked.

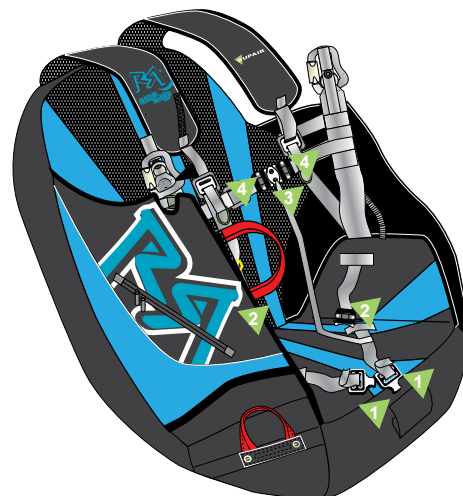

- 1 Thigh strap quick-release buckles (female).
- 2 Thigh strap quick-release buckles (male).
- 3 Safe-T-Bar® SUPAIR patent A-1832/981
- 4 Chest strap quick-release buckles (female).

Take-off

Check that you are securely fastened inside your harness with its speed-bar properly connected, so not to impede your running phase.



Do not release your hands from the toggles when close to the ridge.

In flight

As soon as you are airborne, the behavior is very instinctive and precise.

Please set the distance between the two carabiners according to aerology conditions and to the wing manufacturer's recommendations.



Tightening provides more stability but less harness piloting efficiency. Beware of the increased risk of riser twisting. On the contrary, loosening the strap provides more efficiency but can be dangerous in turbulent aerology (increased risk of falling towards the collapsed side of your glider).

Speed-bar use

We recommend a careful use of the speed-bar due to the increased risk a possible frontal collapse. Please carefully read your glider's operation manual.

To use the speed-bar, maintain one foot on the footrest then with the other, place your foot onto the centering space and push the first bar.

landing

Straighten yourself in your harness and adopt a running posture to dissipate the horizontal speed.

Do not land whilst in the seated position, this is dangerous.



In case of the paraglider jettisoning followed by the BASE canopy deployment, here are a few pieces of information to know to guaranty your safety :



- The BASE System requires a 100 m minimum height over any obstacle to be considered safe. The certification tests demonstrated that a 2 second minimal fall before deployment takes place. Below this minimum height to activate the BASE System, it is vital to use the second rescue parachute located beneath the seat.



- Do not leave your hand(s) in the risers or in the toggles during the paragliding wing jettisoning. The base WING opening sequence could be slowed down or stopped altogether. A riser twist during opening could take place but is unlikely. Be ready to untwist yourself immediately with precis and strong arm and or body gestures.



- A riser twist during opening could take place but is unlikely. Be ready to untwist yourself immediately with precis and strong arm and/or body gestures. Once the BASE wing is opened, if you wish to control your trajectory, it will be imperative to free both the BASE wing's toggles. Unfastening one toggle only will send the wing in a counter rotation opposed to the released brake toggle. The BASE wing is pre-set to a slow flying position upon opening, and will fly a 1 glide in a high horizontal component. However, we will recommend you taking control of your trajectory whilst flying under the ABSE wing.

- Wing behavior in flight : the glider is easily guided but with a 2.5 glide, correctly evaluate the distance to cover to reach the targeted landing area. A sustained ample braking impute 4-5 m over the ground must be implemented.





Packing the BASE wing properly is of utmost important. A poorly executed folding or a simple mistake could have very serious consequences.

You will find on the CD in addition to this notice

In case of an unfolded wing, its repacking must be conducted at :

- a certified specialized repacking or repair facility (approved by us).
- by a qualified third party (skydiving repacking specialist).
- by yourself, but only if you deem your repacking technical knowledge to be good enough to carry out the job on your own.

In either case, the following displayed information in this chart can be useful to you :

Manufacturer	ATAIR/ ADRENALIN BASE
Model	Troll 2-255 R
Surface area (square feet)	255
Gore number	7
Folding type	Pliage dans l'axe
Certification number	EN 12491 : EP 062.2012 LTF : RG 062.2012
Glide ratio	2.5
Extractor	NON
Slider	NON

Using the reserve parachute.



We strongly advise you to check frequently the location of the reserve parachute handle location. To do this, we recommend that you lower your right hand following the risers. This movement should be done without looking. By doing so, you will maximize your chances of a rapid extraction if something went wrong and throwing the reserve parachute was called for. Evaluate your height over the ground. If you have a lot of altitude, it may be better to attempt a wing recovery to normal flight. But if in any doubt, then deploy your rescue parachute.



Deploying a rescue parachute should be done only in an emergency.

With a strong, lateral and then vertical tug, pull the handle towards you and then throw the whole parachute (including the bag and handle) as hard as you can towards a clear area of sky. As soon as the parachute deploys, haul down the glider by pulling as symmetrically as you can on the risers (C or d D) or on the brakes.

Be prepared to land by adopting an upright position, with knees together and legs slightly bent. Prepare to roll down with pivoting shoulders. PLF (Parachute Landing Fall).



Using the rescue parachute located beneath the seat may be the only possible alternative if the pilot falls into his wing.

Release system MONTHLY check

It is imperative to check the release system at least once a month : the following points to check are as follows :



- Soften the main bridle at the carabiner connections to the paraglider risers. Omitting that step, will lead to the stiffening of the release system's bridle and potentially prevent the glider from being jettisoned if needed.
- The ACRO BASE handle cable must be cleaned with a clean dry cloth and lubricated with silicone, but NEVER with oil or any other greasy product. It would be detrimental to your safety and dangerous.
- Check all cables for any asperities (on the entire length, including the extremities). An asperity could lead to an improper functioning of the release mechanism and elevate your safety risk factor. Check the flat loop (see illustration) which must not have any defect or fraying as it could lead to a sudden unwanted and unilateral jettisoning of the paragliding wing.
- Conduct a dorsal opening sequence by pulling the pod bridle (red bridle).

Mandatory biannual check

In addition to the monthly check, it is imperative to proceed with the verification of the following points :



- Check the proper functioning of the rescue parachute located beneath the seat (pull the handle to check for smooth pod extraction).
- Lubricate the cables then dry them with a dry cloth. It is important for the lubrication to be made with silicone only, and NOT any other greasy product which could hinder the release mechanism opening sequence. It would be detrimental to your safety and dangerous.

Annual check

In addition to all monthly and biannual verifications, it is imperative to do the followings :



- An opening and repacking of the BASE conducted at an approved certified specialized facility, or by an authorized competent person.
- An opening and repacking of the rescue parachute located beneath the seat at an approved specialized facility or authorized competent person.

Washing and harness maintenance.

It is a good idea to wash your harness from time to time. We recommend using a soft solvent (such as soap), use a brush and rinse thoroughly. DO NOT use chemicals such as aggressive detergents or strong solvents as they may deteriorate the webbing, stitching and harness fabrics.

The zip fasteners should be lubricated from time to time, using a silicon spray only.

If your harness gets wet, it is advisable to treat your automatic buckles and carabiners with silicone grease from time to time.

Storage and transport.

When not using your harness, store it inside your paragliding rucksack, in a dry, cool and clean place, protected from UV exposure. If your harness is wet, please dry it thoroughly before storing. During transport, protect the harness from any mechanical or UV deterioration (use a bag). Please avoid long transports in wet or humid conditions.

Product longevity.

Independently from the pre-flight checks, you must open and unfold your rescue parachute once every 6 months.

Once every 2 years, you need to perform a complete harness check : :

- webbings (no excessive wear, no rip beginning, no unwanted folds) buckles and carabiners



The threads making the webbing and fabrics used in the ACRO BASE System have been selected to offer the best possible light weight to longevity ratio. Nonetheless, in some conditions, after long term exposure to UV and/or significant abrasion or exposure to chemicals, it is compulsory to have your harness's integrity checked at a certified repair centre. Your safety depends on it.



These carabiners must never be used for anything else than paragliding (not for climbing, no towing, etc.).

Carabiners must be replaced by new ones every five (5) years by identical models or models recommended by the manufacturer (SUPAIR).

Repair

Though we use the highest quality materials, it is possible that your harness may eventually deteriorate through general use. If showing any signs of significant wear and tear, you should check it and have it repaired at a certified repair centre if necessary.



SUPAIR also offers the possibility for its products to be repaired beyond the end of the warranty period. Please contact us either by telephone or by E-mail sav@supair.com in order to receive a quotation.

Materials

Fabrics

CORDURA®
CORDURA® RIPSTOP

Under the seat parachute risers
Polyester 20 mm (1600 daN)

Webbings

Polyamide 20 mm (500 daN)
Polyester 25 mm (1250 daN)
Polyester 28 mm (1500 daN)
Polyester 43 mm (2200 daN)

Recycling

All our materials are selected for their technical and environmental characteristics. None of the components found in our harnesses will harm the environment. Most of them are recyclable. If you estimate that your harness has reached the end of its lifespan, you can then separate the plastic from the metallic parts and apply up-to-date sorting rules in effect in your community. As for the fabric parts, we will advise you to contact your local specialized recycling center(s).

Warranty

SUP'AIR takes the greatest care in the design and production of its product line, hence, offers a five (5) years limited warranty from the purchase date against any manufacturing defect or design issues occurring during normal use. Any damage or degradation resulting from incorrect or abusive use, abnormal exposure to aggressive factors, including, but not limited to; high temperature, intense sun exposure, high humidity etc., will invalidate this warranty

Disclaimer



Paragliding is an activity requiring, skills, specific knowledge and sound judgement. Be safe by learning in certified schools, subscribe and obtain an adequate insurance policy as well as a flying license while always making sure your flying skills are up to the task and weather conditions. SUP'AIR cannot be held responsible for your paragliding decisions or activities.



This SUP'AIR product has been designed exclusively for paragliding. Any other activity such as skydiving or BASE jumping is absolutely forbidden.

Pilot's gear



This is essential that you carry a helmet, suitable boots and clothing. Carrying a reserve parachute suitable for your weight and correctly connected to your harness is also very important.

We propose you optional accessories that combine perfectly to your ACRO BASE SYSTEM harness.

Function	Code	Description	Weight
Rescue parachute	PARASUPAIR08 S	Parachute Supair light S (PTV Max 85kg)	1210 g
	PARASUPAIR08 M	Parachute Supair light M (PTV Max 110kg)	1510 g
	PARASUPAIR08 L	Parachute Supair light L (PTV Max 135kg)	1850 g

All the information for the accessories are provided with the product or are easy to access on our website www.supair.com



This page will help you to record all the life stages of your ACRO BASE System harness.

Serial number :

Purchase date	
Owner's name	
Name and stamp of the shop	

<input type="checkbox"/> Care	
<input type="checkbox"/> Resale	
Date	
Workshop's name/ Buyer's name	

<input type="checkbox"/> Care	
<input type="checkbox"/> Resale	
Date	
Workshop's name/ Buyer's name	

<input type="checkbox"/> Care	
<input type="checkbox"/> Resale	
Date	
Workshop's name/ Buyer's name	

<input type="checkbox"/> Care	
<input type="checkbox"/> Resale	
Date	
Workshop's name/ Buyer's name	

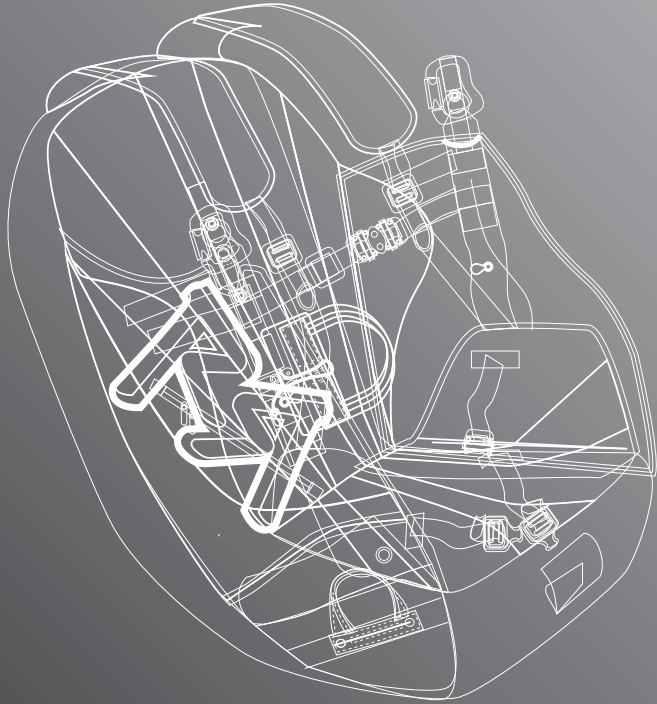

SUPAIR-VLD
PARC ALTAÏS
34 RUE ADRASTÉE
74650 ANNECY CHAVANOD
FRANCE

45°54.024'N / 06°04.725' E



SUPAIR manufactures its products in Europe.
The majority of the components used come from Europe.